

Amarcord

by Romeo Sozzi
Schränke / 1998



Amarcord

by Romeo Sozzi

Schränke / 1998



Design und Eigenschaften

„Amarcord“ ist ein modulares Schrank. Die Grundstruktur ist aus Holz (in diversen Arten erhältlich), die Türen können in Holz oder gehämmerter Bronze gestaltet werden, die Griffe eingelassen oder aus Bronze. Innen ist er mit LED-Beleuchtung und Leder ausgestattet. „Amarcord“ kann mit einer umfassenden Auswahl an Zubehör ausgestattet und individuell konfiguriert werden. „Amarcord“ präsentiert sich 2019 in einer kostbaren Ausführung aus hellgrauem Mahagoni und Türen mit Intarsien aus Amaranth-Holz, hellgrauem Mahagoni und Teak.



Amarcord

by Romeo Sozzi

Schränke / 1998

Abmessungen

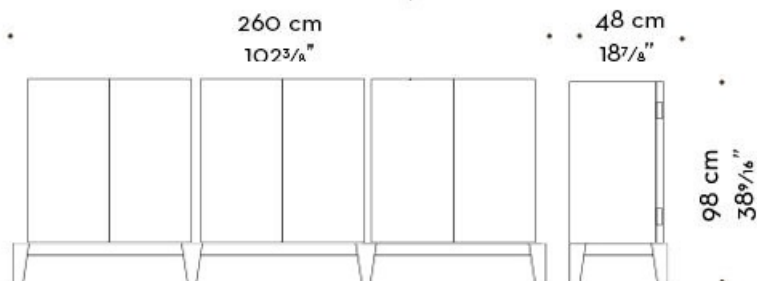
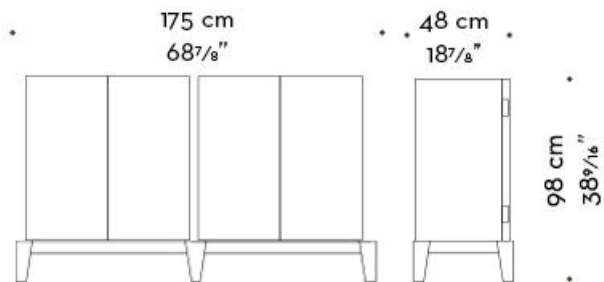
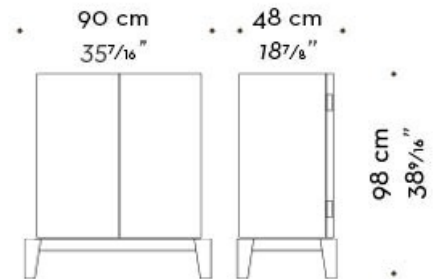
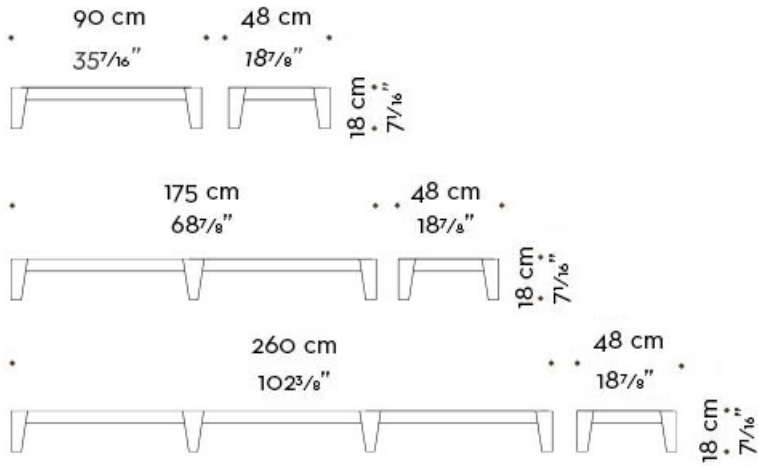

Amarcord

by Romeo Sozzi

Schränke / 1998

80 cm
31½"

46 cm
18⅞"

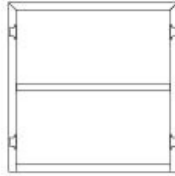
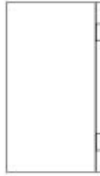
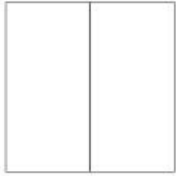

80 cm
31½"



46 cm
18⅞"

vista interno
inside view

80 cm
31½"

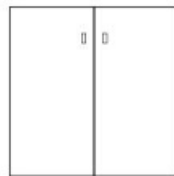

frontali in bronzo
hammered bronze

80 cm
31½"

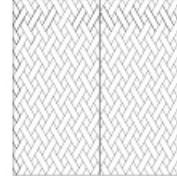

MOD. MASHRABIYA

69 cm
27⅜"

39 cm
15⅜"

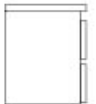

47,5 cm
18⅞"

